



Air Starters

150T™ “F” Series



For engine displacement of: Diesel–300 to 3600 CID (5 to 60 liters)
Carburated–1000 to 7200 CID (16 to 120 liters)*

Features/Benefits

- Provides 35% more output torque than 150T™ “E” Series Model
- Same inlet and outlet locations as the 150BM and 150T™ “E” Series starters for easy change-out
- Uses the proven front end of the 150BM starter
- Provides maintenance-free operation
- Sealed for use in gas and air applications
- Efficient 30 hp turbine motor uses no external lubrication

Versatile

- Inertia and pre-engaged models available
- Left- and right-hand rotation available
- 4 inlet, 4 exhaust, and 16 drive housing orientations
- 30-150 psi (2.1-10.3 bars) operation

* These values may vary depending on engine-specific parasitic loads.



Industry applications ideal for the 150T Series starters: marine, trucking, transit, oil and gas.

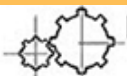

LOUZAMPINI & ASSOCIATES

Five Star Desoutter
★★★★★
Factory Authorized Dealer

Please Call **1-800-353-4676** for questions, pricing, or to order. We will be happy to assist you.

150T™ "F" Series DIMENSIONS

Weight lbs (kg)
150T 35 (15.9)

Note: All dimensions shown are for reference only. Specifications subject to change without notice.

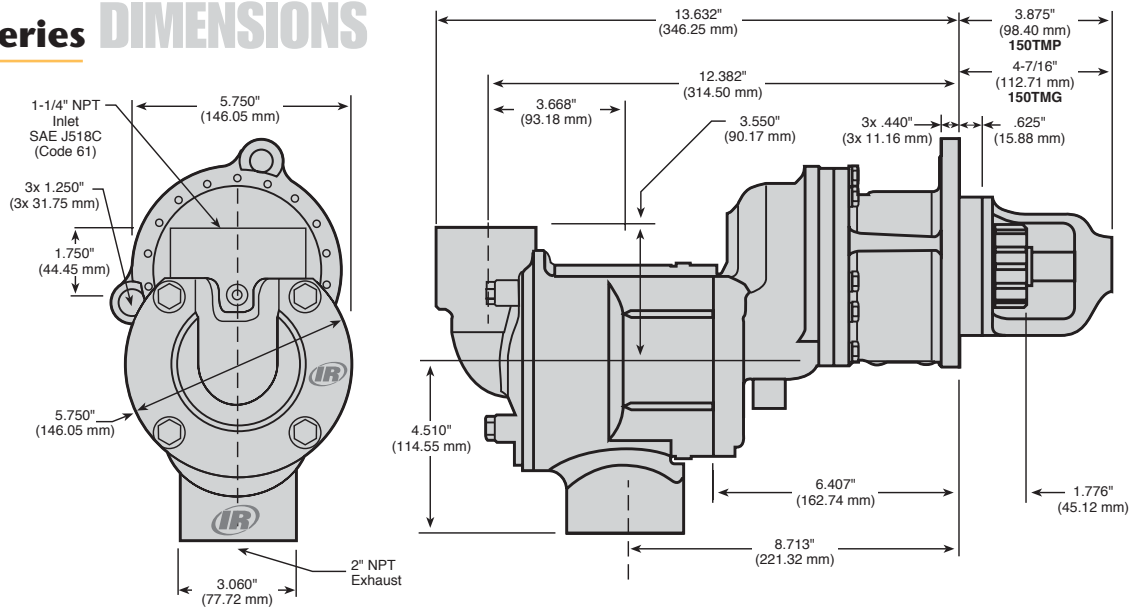

150TMPF/150TMGF Performance Information – 44% Arc

Pressure PSI (bar)	Breakaway Torque ft-lb (Nm)	Speed @ Max HP RPM	Max Power HP (kw)	Flow @ Max HP SCFM (L/s)
60 (4.1)	74 (100)	1296	9 (7)	310 (146)
90 (6.2)	113 (153)	1480	16 (12)	430 (203)
120 (8.3)	147 (200)	1580	22 (17)	570 (269)
150 (10.3)	182 (247)	1620	28 (21)	710 (335)

150TLPF Performance Information – 99% Arc

Pressure PSI (bar)	Breakaway Torque ft-lb (Nm)	Speed @ Max HP RPM	Max Power HP (kw)	Flow @ Max HP SCFM (L/s)
30 (2.1)	72 (98)	1185	8 (6)	340 (160)
60 (4.1)	132 (179)	1500	19 (14)	580 (274)
90 (6.2)	206 (280)	1530	30 (23)	780 (368)

150T™ "F" Series Number of Starts per Tank

(Data taken from crank tests on Detroit Diesel Series 50 with an Allison Transmission)

Max Tank Pressure (psi)	Tank Size									Max Tank Pressure (bar)
	40	60	80	100	120	140	160	180	200	
300	19	28	37	47	56	65	75	84	20	
270	16	24	33	41	49	57	65	73	18	
240	14	21	28	35	42	49	56	63	16	
210	12	17	23	29	35	41	47	52	14	
180	9	14	19	23	28	33	37	42	12	
150	7	10	14	17	21	24	28	31	10	
120	5	8	9	12	14	16	19	21	8	
90	2	3	5	6	7	8	9	10	6	
	40	60	80	100	120	140	160	180		
	151	227	302	378	454	529	605	680		

**Gallons
Liters**

150T™ “F” Series

Bold Model Numbers indicate that a remanufactured model is available with the same part number (add an “R” to the number).

150T™ “F” Series Crossover Model Numbers

Most Obsolete Units ▶

150T™ “F” Available Units	150BM Crossovers	150LF Crossovers	150BM Obsolete	150BM Obsolete	10BM Obsolete	9BM Obsolete
150TMF21RH-31	150BME21RH-31			101BMPC78RH-31	10BMB21RH-31	
150TMGF12RH-13	150BMGE12RH-13			150BME12RH-13	10BMB12RH-13	9BMA43RH-13
150TMGF21LH-11	150BMGE21LH-11	150LFGE21LH11-000	150BME21LH-11		10BMB21LH-11	9BMB31LH-11
150TMGF21LH-11	150BMGE21LH-11				10BMB22LH-8	9BMA32LH-8
150TMGF21LH-32	150BMGE21LH-32					
150TMGF21RH-6	150BMGE21RH-6	150LFE21RH6-020	150BME21RH-6		10BMB21RH-6	9BMA331RH-6
150TMGF21RH6-22R	150BMGE21RH6-22R	150LFGE21RH6-000	150BME21RH-17			
150TMGF22RH-5	150BMGE22RH-5	150LFGE22RH5-020	150BME22RH-5			
150TMGF22RH5-10D	150BMGE22RH5-10D		150BMGE22RH-5		10BMB12RH-13	9BMA43RH-13
150TMPF88L54-020	150BMPD88L54-020					
150TMPF88R54-020	150BMPD88R54-020		150BMPD88R-46	150BMPD89RH-46	150BMPAC03R85	
150TMPF81R15-00N	150BMPE81R15-00N	150LFPE81R15-020				
150TMPF88L54-11A	150BMPE88L54-11A			150BMPD89LH-50	101BMPC78LH-11	
150TMPF88L54-12E	150BMPE88L54-12E		150BMPE88L-11	150BMPE78LH-11		
150TMPF88L54-13E	150BMPE88L54-13E		150BMPE88L-11	150BMPE83LH-11	10BMB21LH-11	9BMB31LH-11
150TMPF88L54-200	150BMPE88L54-200	150LFPE88L54-000				
150TMPF88L54-20N	150BMPE88L54-20N					
150TMPF88L54-22N	150BMPE88L54-22N					
150TMPF88L54-33A	150BMPE88L54-33A					
150TMPF88L54-33C	150BMPE88L54-33C					
150TMPF88R51-200	150BMPE88R51-200	150LFPE88R51-020				
150TMPF88R53-000	150BMPE88R53-000		150BMPE88R-53	150BMPE78RH-53	101BMPC78RH-38	
150TMPF88R53-020	150BMPE88R53-020	150LFPE88R53-020	150BMPE88R-53	150BMPE78RH-5	10BMB22RH-5	9BMA32RH-5
150TMPF88R53-12F	150BMPE88R53-12F					
150TMPF88R53-200	150BMPE88R53-200					
150TMPF88R53-300	150BMPE88R53-300					
150TMPF88R54-000	150BMPE88R54-000	150LFPE88R54-000	150BMPE88R-44	150BMPE78RH-44	101BMPB78RH-44	
150TMPF88R54-00N	150BMPE88R54-00N	150LFPE88R54-00N	150BMPE88R-54	150BMPE78RH-54		
150TMPF88R54-02E	150BMPE88R54-02E	150LFPE88R54-02E		150BMPE78RH-6	101BMPC78RH-6	
150TMPF88R54-12C	150BMPE88R54-12C					
150TMPF88R54-12D	150BMPE88R54-12D	150LFPE88R54-12D				
150TMPF88R54-12E	150BMPE88R54-12E	150LFPE88R54-12E				
150TMPF88R54-200	150BMPE88R54-200	150LFPE88R54-200				
150TMPF88R54-20E	150BMPE88R54-20E					
150TMPF88R54-220	150BMPE88R54-220					
150TMPF88R54-22E	150BMPE88R54-22E					
150TMPF88R54-300	150BMPE88R54-300	150LFPE88R54-300				
150TMPF88R54-32P	150BMPE88R54-32P					
150TMPF88R54-POS	150BMPE88R54-POS					

Simple Crossover:

Current 150BM models are superseded to the 150T™ “F” models by replacing the “B” with a “T” AND the “E” with an “F”

Example: 150**B**MPE88R54 = 150**T**MP**F**88R54

For low pressure applications (less than 90 psi or 6.2 bar) replace the “M” with an “L”

Example: 150**M**PE88R54 = 150**L**PF88R54

150T™ “F” SERIES MODEL CODING

150 T M G F 21 RH 6 0 2 F

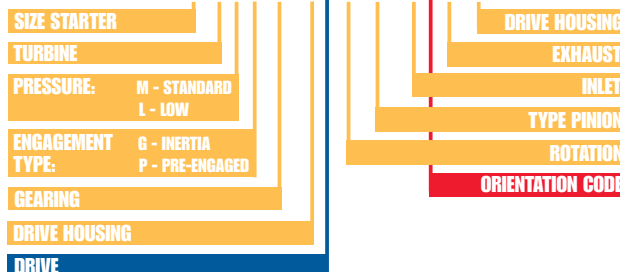

Air Starters

150T™ “F” Series Accessories

See catalog pages J-1 to J-18 for detailed Accessory information.

IR Part #	Description	Picture
1 ST500-674 or 150T-311	2" Muffler	
2 150BMP-1051B	1/4" 12 V Solenoid Valve	
3 150BMP-2451B	1/4" 24 V Solenoid Valve	
4 SMB-618	Push Button Valve	
5 SMB-G618	Gas Rated Push Button Valve	
6 SRV125F	1-1/4" Relay/Solenoid Valve For Transit New builds	
7 SRV125T	1-1/4" Relay Valve For Transit Aftermarket	
8 SRV125	1-1/4" Relay Valve For Stationary Air	
9 SRV150SS	1-1/2" Gas Rated Relay Valve	

IR Part #	Description	Picture
10 150BMP-1058	Gladhand	
11 150BMP-1064	1/8", 150 psi Pressure Gauge	
12 ST900-267-24	1-1/2" Strainer (300 Mesh)	
13 ST900-266-24	1-1/2" Strainer Element (300 Mesh)	
14 ST500-A735	2" Road Splash Deflector	
15 150BMP-1056	1/2" Check Valve	
16 150BMP-1067	1/2" Drain Valve	
17 ST500-K166	SAE J518 Split Flange	
18 ST500-K740	Exhaust Tube Kit	
19 60RS26-1	Flanged 60-gallon tank; 26" O.D.	

Red item numbers correspond to numbers in diagrams on page A-4.

150T™ “F” Series Genuine Ingersoll-Rand Replacement Kits

Tune Up Kit Part Number	Description
150TMP-TK1	150T Pre-engaged Starter Tune Up Kit
150TMG-TK1	150T Inertia Starter Tune Up Kit



150TMP-TK1 Parts



150TMG-TK1 Parts

150T™ Series Motor Modules

Motor Module Part Number	Description
150TMFR-100	RH Half Arc Motor Module
150TMFL-100	LH Half Arc Motor Module
150TLFR-100	RH Full Arc Motor Module
150TLFL-100	LH Full Arc Motor Module

Note: The motor module can be used to convert an E ratio to an F ratio 150T starter and includes the motor and the gearing section.

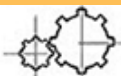

150T™ “F” Series

150T (Gas) Stationary Installation

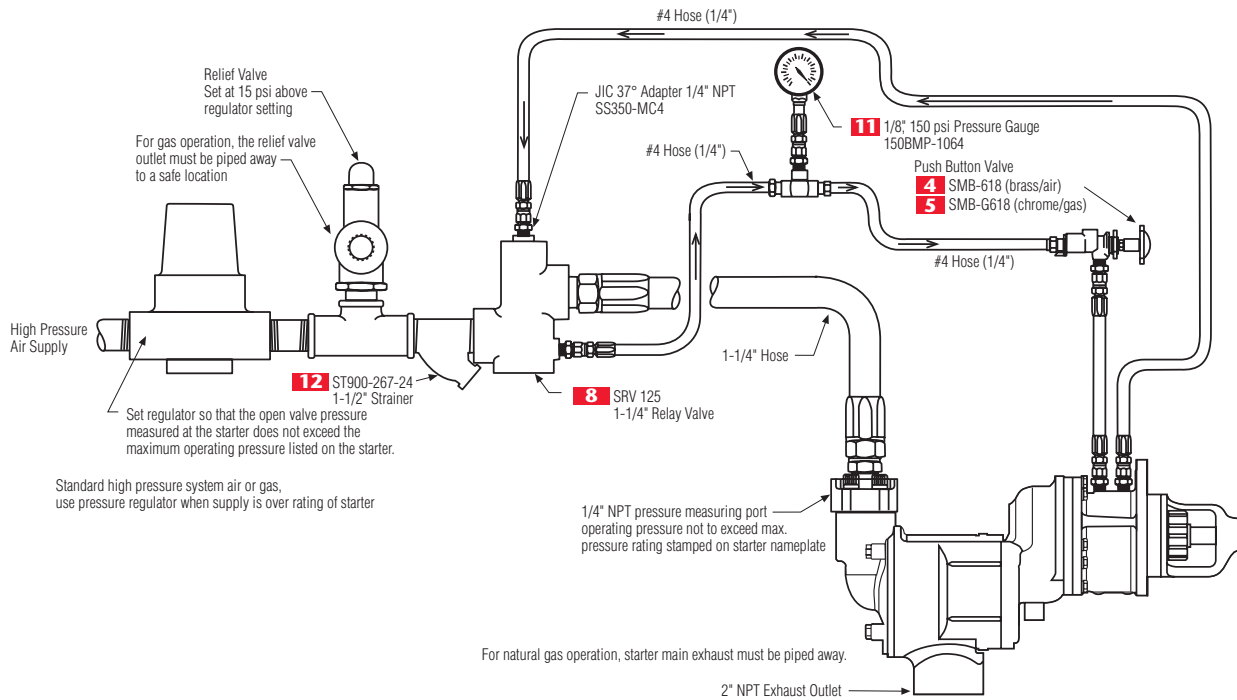

150T Typical Vehicular Installation

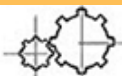
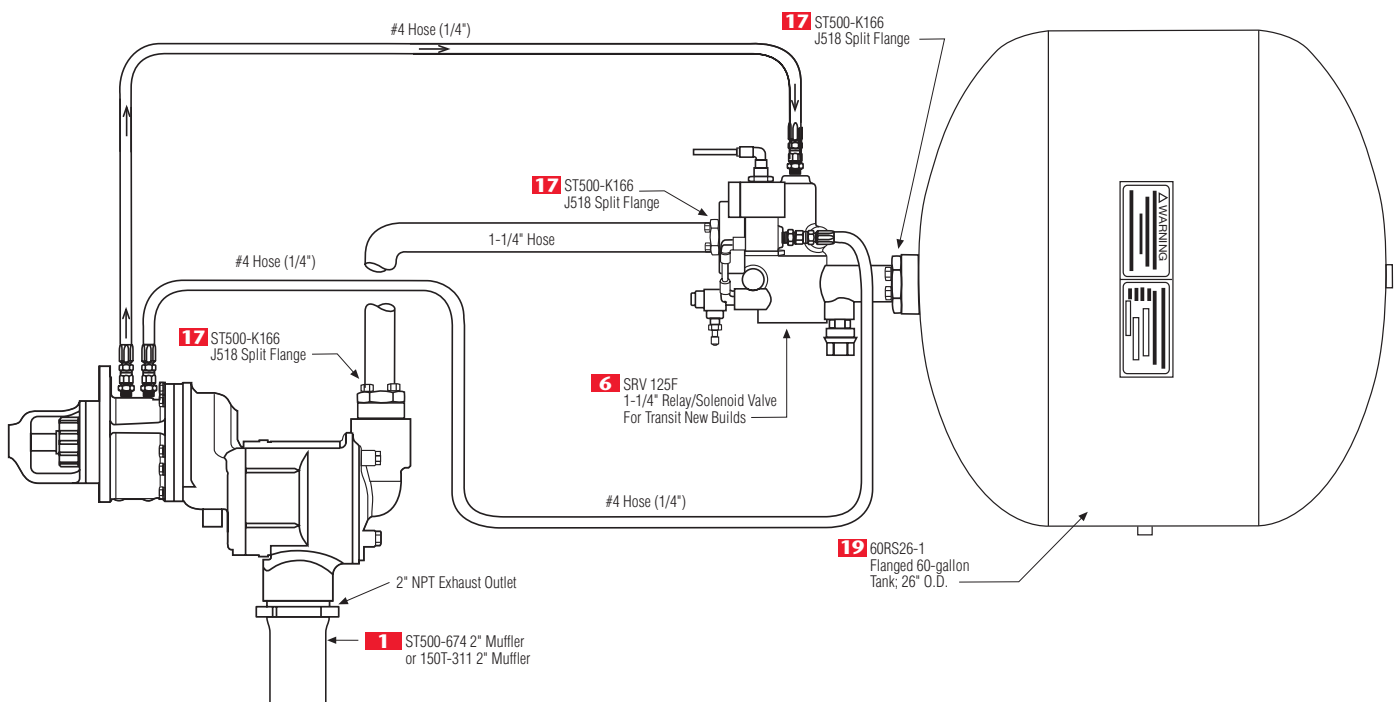



Series 150T Air Starters

This chart is a condensed list of engines that can be cranked with an IR starter. For a complete list, please contact IR.

150T™ “F” Series Engine Selection Guide

Manufacturer	Engine	CID	Liter	CYL	Type	Turbine Starter
CATERPILLAR	3126	439	7.2	6	Diesel	150TMPF81R15
	3176	629	10.3	8	Diesel	150TMPF88R54
	3406	893	14.6	6	Diesel	150TMPF88R54
	3408	1099	18	8	Diesel	150TMPF88R54
	D-334	638	10.5	6	Diesel	150TMPF88R53
	D-336	700	11.5	8	Diesel	150TMPF88R53
	D-343	893	14.6	6	Diesel	150TMPF88R54
	D-346	1191	19.5	8	Diesel	150TMPF88R54
	G-342	1246	20.4	6	Nat. Gas	150TMPF88R54
CES-AJAX	DP125	2205	36.1	1	Nat. Gas	150TMGF21LH-11
	DP165	2826	46.3	1	Nat. Gas	150TMGF21LH-11
	DPC180	2826	46.3	1	Nat. Gas	150TMGF21LH-11
	DPC60	850	14	1	Nat. Gas	150TMGF21LH-11
CLIMAX	K67	1616	26.5	6	Gas	150TMPF88R53
	K75	1855	30.4	6	Gas	150TMPF88R53
	R165	1238	20.3	6	Gas	150TMPF88R53
CONTINENTAL	R602	602	9.9	6	Gas	150TMPF88R53
	R6513	513	8.4	6	Gas	150TMPF88R53
	U6501	501	8.2	6	Gas	150TMPF88R53
CUMMINS	ISC	506	8.3	6	Diesel	150TMPF88R53
	ISL	549	9	6	Diesel	150TMPF88R53
	ISM	660	10.8	6	Diesel	150TMPF88R54
	QSK19	1150	19	6	Diesel	150TMPF88R54
	ISM	659	10.8	6	Diesel	150TMPF88R54
	ISX	915	15	6	Diesel	150TMPF88R54
DETROIT DIESEL	6V-71	426	7	6	Diesel	150TMGF21RH6
	6V-92	552	9	6	Diesel	150TMGF21RH6
	Series 50	519	8.5	4	Diesel	150TMPF88R54
	Series 60	778	12.7	6	Diesel	150TMPF88R54
EMD GM	12-645	7740	126.8	12	Diesel	2-150TMPF88R54
	12-710	8520	139.6	12	Diesel	2-150TMPF88R54
	16-645	10320	169.1	16	Diesel	2-150TMPF88R54
	16-710	11360	186.2	16	Diesel	2-150TMPF88R54
	20-645	12900	211.4	20	Diesel	2-150TMPF88R54
	20-710	14200	232.7	20	Diesel	2-150TMPF88R54
	8-645	5160	84.6	8	Diesel	150TMPF88R54
	8-710	5680	93.1	8	Diesel	150TMPF88R54
WAUKESHA	145GZ	817	13.4	6	Nat. Gas	150TMGF22RH5
	6GAK	784	12.8	6	Nat. Gas	150TMGF22RH5
	6WAK	1197	19.6	6	Nat. Gas	150TMGF21RH6
	F1197G	1197	19.6	6	Nat. Gas	150TMGF21RH6
	F119G	1197	19.6	6	Nat. Gas	150TMGF21RH-6
	H1077G	1077	17.6	8	Nat. Gas	150TMGF21RH6
	H24L	1462	24	8	Nat. Gas	150TMGF21RH6
	H867D	866	14.2	8	Diesel	150TMPF88R53
WHITE ENGINES	DFXD	855	14	6	Diesel	150TMPF88R54
	DFXE	895	14.7	6	Diesel	150TMPF88R54

